

1-Phase PV Grid-Connected Inverter
Quick Installation Guide
SG8.0RS-L / SG9.0RS-L / SG10RS-L



1. Contents may be periodically updated or revised due to product development. The information in this guide is subject to change without notice. In no case shall this guide substitute for the user manual or related notes on the device.
2. Make sure to read over, fully understand and strictly follow the detailed instructions of the user manual and other related regulations before installing the equipment. The user manual can be downloaded by visiting the website at <http://support.sungrowpower.com/>; or it can be obtained by scanning the QR code on the side of the equipment or the back cover of this guide.
3. All installations must be performed by qualified personnel who should have training for installation and commissioning of electrical system, as well as dealing with hazards, have knowledge of the manual and of the local regulations and directives.
4. Before installation, check that the package contents are intact and complete compared to the packing list. Contact SUNGROW or the distributor in case of any damaged or missing components.
5. The cable used must be intact and well insulated. Operation personnel must wear proper personal protective equipment (PPE) all the time.
6. Any violation could result in personal death or injury or device damage, and will void the warranty.

Safety

The inverter has been designed and tested strictly according to international safety regulations. Read all safety instructions carefully prior to any work and observe them at all times when working on or with the inverter. Incorrect operation or work may cause:

- injury or death to the operator or a third party;
- damage to the inverter and other properties.

Please follow the safety instructions related to the PV strings and the utility grid.

DANGER

Lethal voltage!

- PV strings will produce electrical power when exposed to sunlight and can cause a lethal voltage and an electric shock.
- Only qualified personnel can perform the wiring of the PV panels.





NOTICE







Danger to life from electric shock due to lethal voltage!

- All electrical connections must be in accordance with local and national standards.
- Only with the permission of the utility grid, the inverter can be connected to the utility grid.

Inverter

The icons on the inverter body are as follows.

 <p>Disconnect the inverter from all the external power sources before maintenance!</p>	 <p>Burn danger due to hot surface that may exceed 60 °C.</p>
 <p>Danger to life due to high voltages! Do not touch live parts for 10 minutes after disconnection from the power sources. Only qualified personnel can open and service the inverter.</p>	 <p>Read the user manual before maintenance!</p>  <p>RCM mark of conformity.</p>

	TÜV mark of conformity.		CE mark of conformity. EU/EEA Importer.
	Do not dispose of the inverter together with household waste.		The inverter does not have a transformer.
	Additional grounding point.		UKCA mark of conformity.

DANGER

Danger to life from electric shocks due to live voltage

- Do not open the enclosure at any time. Unauthorized opening will void warranty and warranty claims and in most cases terminate the operating license.
- When the enclosure lid is removed, live components can be touched which can result in death or serious injury due to electric shock.

Lethal danger from electric shock due to possibly damaged inverter

- Only operate the inverter when it is technically faultless and in a safe state.
- Operating a damaged inverter can lead to hazardous situations that can result in death or serious injuries due to electric shock.

WARNING

Risk of inverter damage or personal injury

- Do not connect or disconnect the PV and AC connectors when the inverter is running.
- Wait at least 10 minutes for the internal capacitors to discharge after all electric devices are removed and the inverter is powered off.
- Ensure that there is no voltage or current before connecting or disconnecting the PV and AC connectors.

WARNING

All the warning labels and nameplate on the inverter body:

- must be clearly visible; and
- must not be removed, covered or pasted.

CAUTION

Risk of burns due to hot components!

- Do not touch any hot parts (such as the heat sinks) during operation. Only the DC switch and the LCD panel can safely be touched at any time.

NOTICE

Only qualified personnel can perform the country setting. Unauthorized alteration may cause a breach of the type-certificate marking.

Risk of inverter damage due to electrostatic discharge (ESD)!

By touching the electronic components, you may damage the inverter. For inverter handling, be sure to:

- avoid any unnecessary touching; and
- wear a grounding wristband before touching any connectors.

1. O conteúdo pode ser periodicamente atualizado ou revisado devido ao desenvolvimento de produtos. As informações contidas neste guia estão sujeitas a alterações sem aviso prévio. Sob nenhuma circunstância este guia deve substituir o manual do usuário ou avisos relacionados no dispositivo.
2. Certifique-se de ler, entender e seguir rigorosamente as informações detalhadas no manual do usuário e outras regulamentações anteriores antes de instalar o equipamento. O manual do usuário pode ser baixado no site <http://support.sungrowpower.com/>, ou pode ser obtido por meio da leitura do código QR na lateral do equipamento ou na contracapa deste guia.
3. Todas as instalações devem ser realizadas por pessoal qualificado, que deve ser treinado em como instalar e comissionar o sistema elétrico, e também em como lidar com perigos, ter conhecimento do manual e das normas e diretivas locais.
4. Antes de instalar, verifique se o conteúdo da embalagem está intacto e completo na lista da embalagem. Entre em contato com a SUNGROW ou com o distribuidor em caso de componentes danificados ou faltando.
5. O cabo utilizado deve estar intacto e bem isolado. O pessoal da operação deve usar equipamento de proteção individual (EPI) o tempo todo.
6. Qualquer violação pode causar ferimentos, morte ou danos ao dispositivo e anulará a garantia.

Segurança

O inversor foi projetado e testado em estrita conformidade com as regulamentações internacionais de segurança. Leia todas as instruções de segurança com atenção antes de realizar qualquer trabalho, seguindo-as sempre que manusear o inversor. A operação ou o trabalho incorreto pode causar:

- ferimentos ou mortes ao operador ou a um terceiro;
- danos ao inversor e a outras propriedades.

Siga as instruções de segurança relacionadas às strings FV e à rede de distribuição.

PERIGO

Tensão letal!

- As strings FV produzirão energia elétrica quando expostas à luz do sol, podendo causar tensão fatal e choques elétricos letais.
- Somente funcionários qualificados podem fazer a fiação dos painéis FV.







AVISO







Perigo à vida em decorrência de choques elétricos por tensão letal!

- Todas as conexões elétricas devem estar de acordo com os padrões nacionais e locais.
- O inversor só poderá ser conectado à rede de distribuição com permissão da rede.

Inversor

Os ícones no corpo do inversor são os seguintes.

 <p>Desconecte o inversor de todas as fontes externas de alimentação antes de fazer manutenção!</p>	 <p>Há riscos de queimadura devido à superfície quente que pode exceder os 60 °C.</p>
  <p>A alta tensão traz riscos à vida! Não toque nas partes energizadas durante 10 minutos após desconectá-las das fontes de alimentação. Só funcionários qualificados podem abrir e fazer manutenção no inversor.</p>	 <p>Leia o manual do usuário antes de fazer a manutenção!</p>  <p>Marca de conformidade RCM.</p>

	Marca de conformidade TÜV.		Marca de conformidade CE. Importador da UE/EEE.
	Não descarte o inversor junto com resíduos domésticos.		O inversor não tem um transformador.
	Ponto de aterramento adicional.		Marca de conformidade UKCA.

PERIGO

Perigo à vida em decorrência de choques elétricos por tensão ativa

- Não abra o compartimento em nenhum momento. A abertura não autorizada anulará a garantia e reivindicações de garantia e, na maioria dos casos, rescindir a licença de operação.
- Quando a tampa do compartimento for removida, será possível tocar nos componentes ativos, o que pode causar mortes ou ferimentos graves por choques elétricos.

O choque elétrico decorrente possivelmente do inversor danificado traz perigo letal

- Só opere o inversor quando ele estiver tecnicamente sem defeitos e em um estado seguro.
- Operar um inversor danificado pode causar situações perigosas que resultam em mortes ou ferimentos graves em decorrência dos choques elétricos.

ADVERTÊNCIA

Risco de danos ao inversor ou ferimentos pessoais

- Não conecte nem desconecte os conectores FV e CA quando o inversor estiver funcionando.
- Aguarde pelo menos 10 minutos para que os capacitores internos sejam descarregados depois que todos os dispositivos elétricos forem removidos e o inversor for desligado.
- Certifique-se de que não haja tensão ou corrente antes de conectar ou desconectar os conectores FV e CA.

ADVERTÊNCIA

No corpo do inversor, todas as etiquetas de advertência e a capacidade anunciada:

- devem estar claramente visíveis; e
- não devem ser removidas, cobertas ou coladas.

CUIDADO

Risco de queimaduras devido aos componentes quentes!

- Não toque nas partes quentes (como os dissipadores de calor) enquanto o dispositivo estiver funcionando. Apenas o interruptor CC e o painel LCD podem ser tocados com segurança a qualquer momento.

AVISO

Somente funcionários qualificados podem executar o ajuste de acordo com o país. A alteração não autorizada pode violar a certificação do dispositivo.

Risco de danos ao inversor devido a descargas eletrostáticas (ESD)!

Se tocar nos componentes eletrônicos, você pode danificar o inversor. Para manuseio do inversor, faça o seguinte:

- evite toques desnecessários; e
- use uma pulseira de aterramento antes de tocar em qualquer conector.

Scope of Delivery / Escopo da entrega

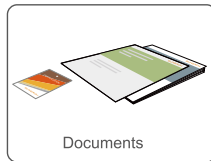
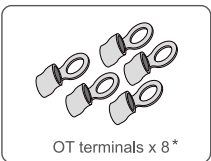
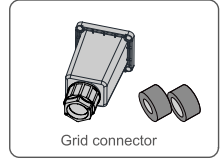
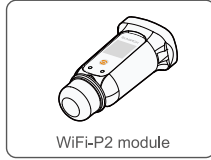
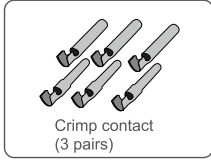
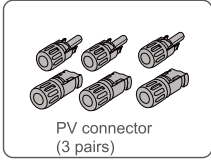
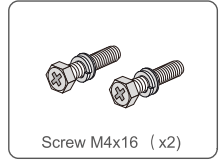
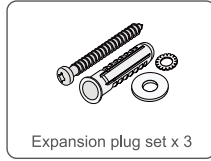
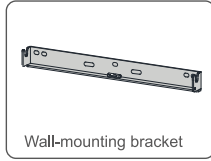
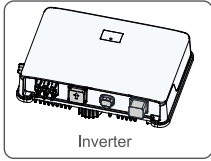

* The images shown here are for reference. The actual quantity is based on delivery.

Mounting location / Local de montagem

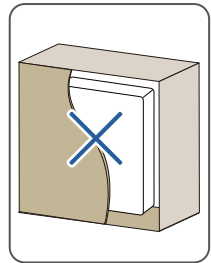
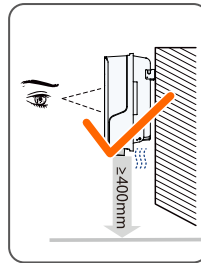
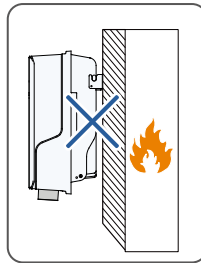
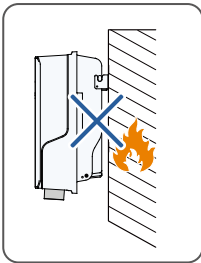
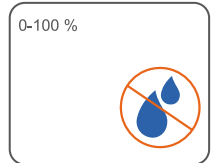
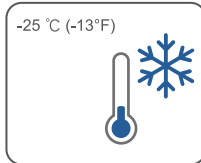
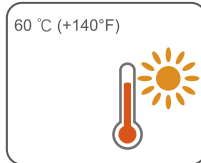

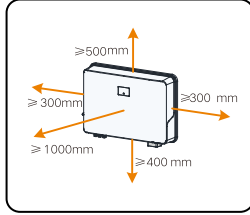
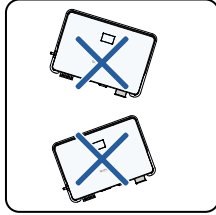
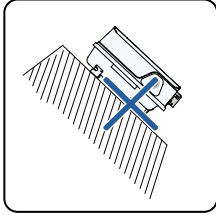
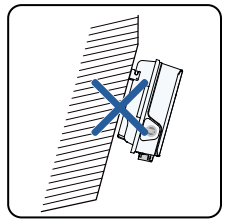
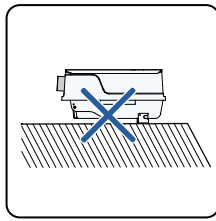
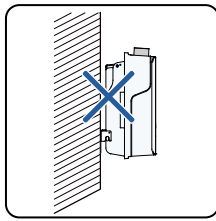
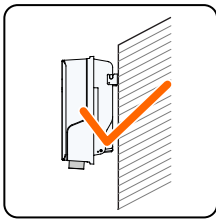

Installation tools / Ferramentas de instalação

Marker



Multimeter: $\geq 600\text{Vdc}$

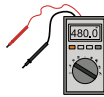

Hammer drill: $\phi 10$

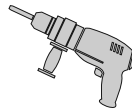

Wire stripper



Hydraulic plier

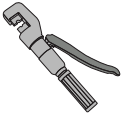

Tube terminal crimping tool: $0.5\text{-}1.0\text{ mm}^2$



Phillips screwdriver: M4

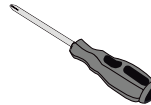

Wrench for MC4 terminal

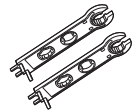

Electric screwdriver: M4, M5, M6



Heat gun



RJ45 Crimping tool

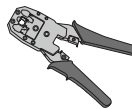

Wrench: 33mm, 35mm



MC4 terminal crimping tool: $4\text{-}6\text{ mm}^2$



Allen wrench

T27



Mounting / Montagem

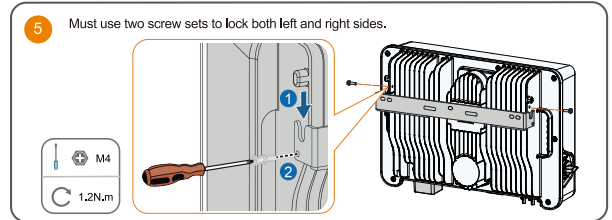
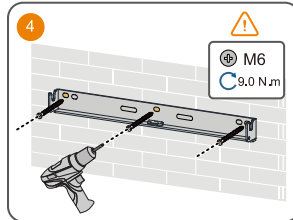
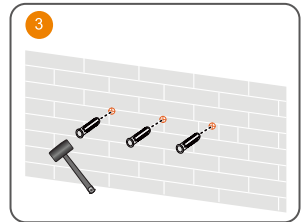
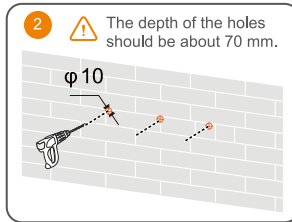
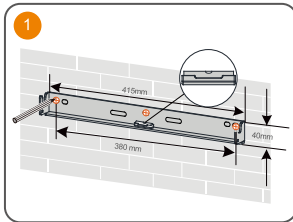

- Use appropriate mounting hardware for wall type.

PE / PE

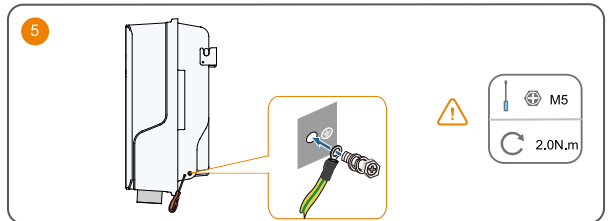
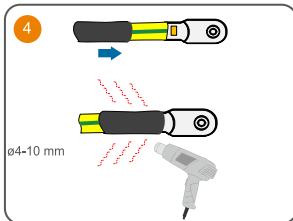
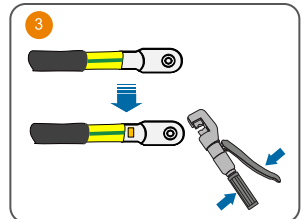
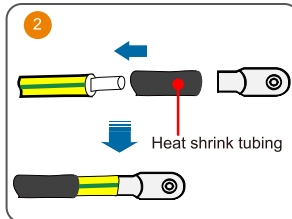
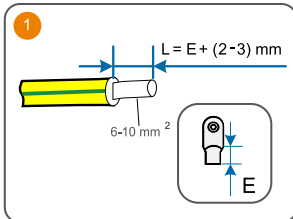

- The cable specification must comply with local regulations (if available). Otherwise, keep it consistent with the PE wire in the AC cable.

AC

It is recommended to use heavy duty conduits when run cables through Cavity walls, or lay out cables with corresponding conduits.
A RCD is not required if either of these two installation methods is adopted according to the local standard AS3000-2018.
(For "AU" and "NZ")

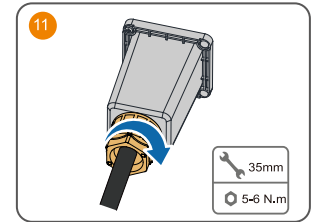
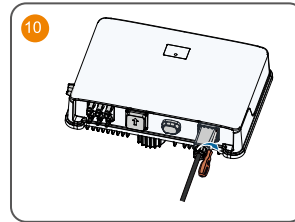
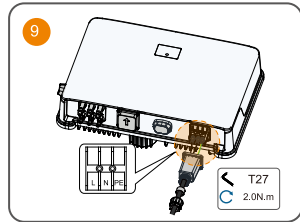
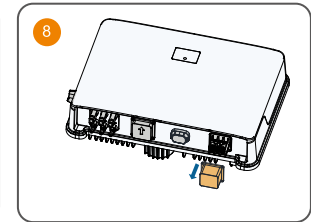
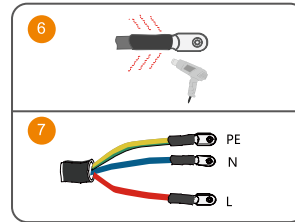
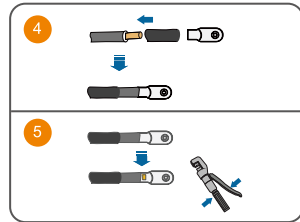
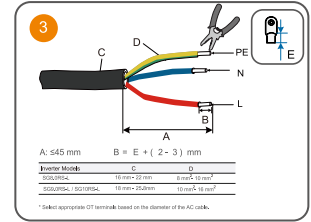
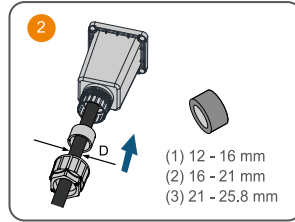
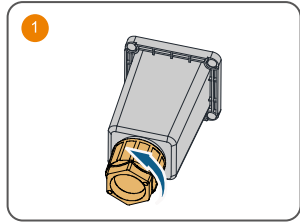
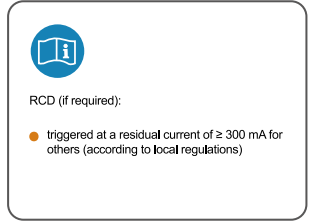
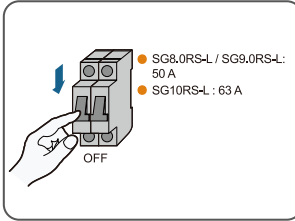
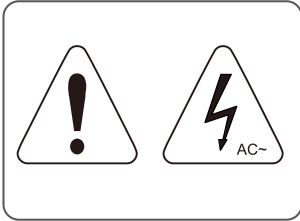

DC

It is recommended to use heavy duty conduits when run cables through Cavity walls, or lay out cables with corresponding conduits.
A RCD is not required if either of these two installation methods is adopted according to the local standard AS3000-2018.
(For "AU" and "NZ")

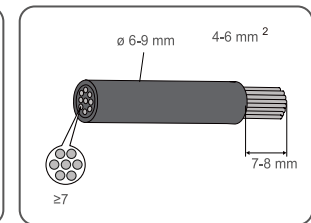
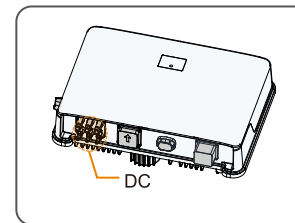
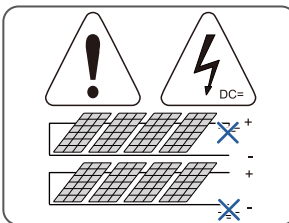

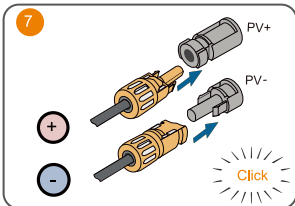
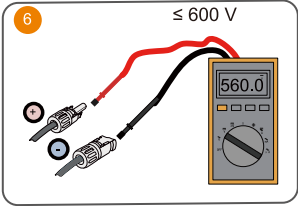
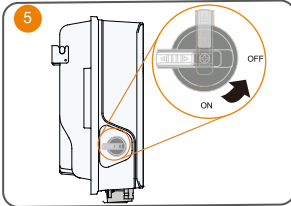
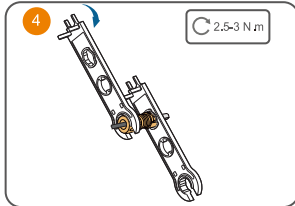
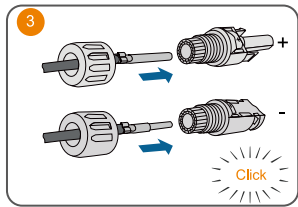
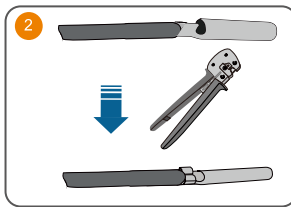
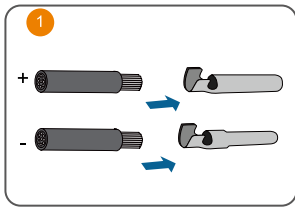

WLAN

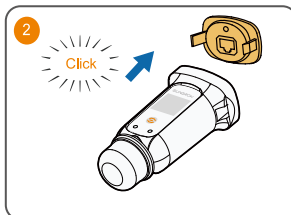
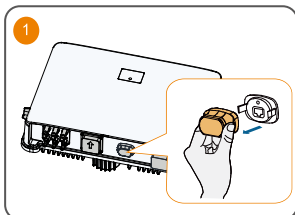

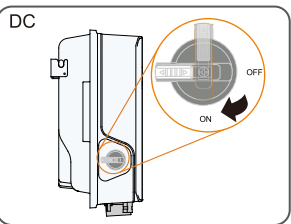
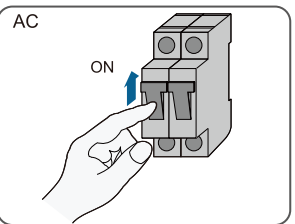

Power on / Ligar

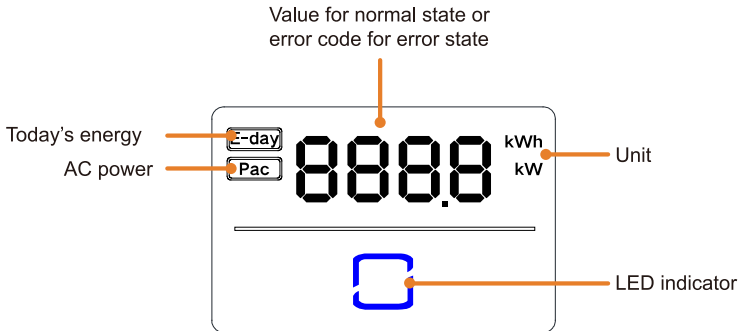



- In normal state, the E-day and Pac information will be displayed alternately. Also you can touch the LED indicator to switch the information.
- In error state, touch the LED indicator to view multiple error codes.
- If there is no operation for 5 minutes, the display screen will be off. Touch the LED indicator to activate it.

LED indicator	LED state	Definition
	ON	The inverter is normally running.
	Flashing	The inverter is at standby or startup state (not feeding power into the grid).
	ON	A system fault has occurred.
	OFF	Both the AC and DC sides are powered down.



More information in the QR code or
at <http://support.sungrowpower.com/>

SUNGROW

Specifications are subject to changes without advance notice.

